

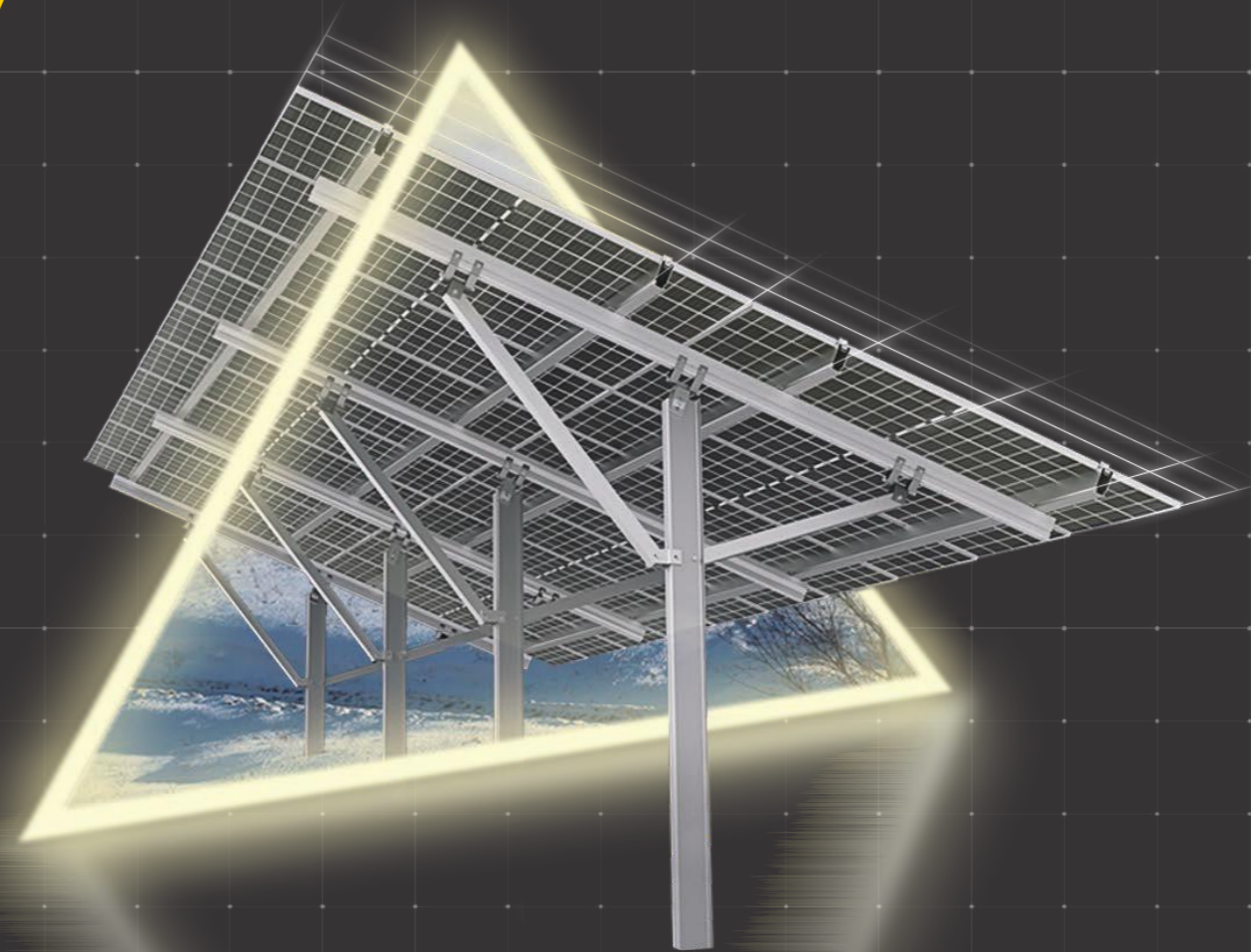

RAISE A GREEN WORLD

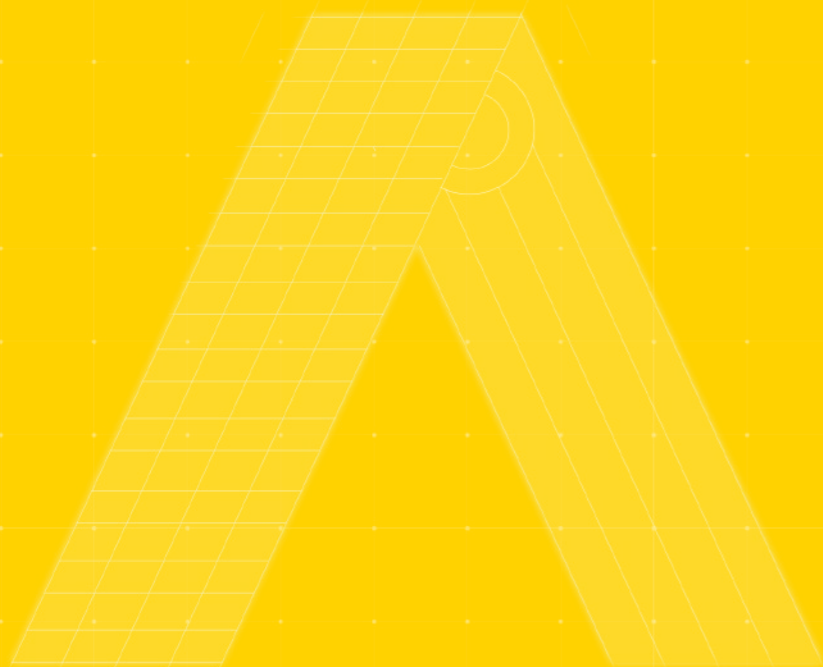

**SOLAR
MOUNTING
SYSTEM**

ANTAI TECHNOLOGY CO.,LTD

Web
www.antisolar.com

HQ Add
30F, W Square, 1801 Huandao East Road
Siming District, Xiamen, China

Production Base Add
Guanshan Industrial Park
Changtai County, Zhangzhou, China



RAISE A GREEN WORLD

Leading supplier of the whole industry chain
in PV mounting system

Offering a diverse product portfolio covering
full-material, full-function of solar tracking
and mounting systems to move towards
zero-carbon future and promote sustainable
development.

ABOUT ANTAI

Antaisolar, the leading supplier of the whole industry chain in PV mounting system. Established in 2006, it has currently built up a manpower of 800 employees with R&D team of 120 specialists of diverse technical background. Antaisolar has been focusing on consistently providing convenient, reliable, and innovative solar mounting and tracking systems over the past years.

Headquartered in Xiamen, China, Antaisolar is based on the mission of "Raise a Green World", and has been continuously optimizing and promoting the global service by setting up branches and offices in Japan, Australia, Brazil, Singapore, Philippines, Vietnam and other regions. As for its producing force, it is distributed within five major manufacturing centers located in Turkey, Indonesia, Fujian, Jiangsu and Tianjin.

As of the end of 2021, its cumulative solar racking shipments had reached 19.3GW. It has ranked No.1 in Japan's solar racking market share and ranked No.1 of export volume to Japan for eight consecutive years and ranked top 1 in Australia and Chile distributed generation market.

ADVANTAGES



01
Front-runner of solar racking

Ranked No.1 in Japan's solar racking market share and ranked No.1 of export volume to Japan for eight consecutive years; Ranked top 1 in Australia and Chile distributed generation market.



02
Vertical integrated production

Manufacturing centers located in Turkey, Indonesia, India, Fujian, Jiangsu, Tianjin. Vertical integrated production with strict process control. 10GW annually capacity of aluminum solar racking and 15GW annually capacity of steel solar racking.



03
R&D innovation

Owns three major R&D bases for solar tracker, fixed structure and high performance material; Highly educated R&D team composed of 120 persons with more than 15 year's experience. Good master of design and architectural standards for global regions.



04
Global localization service

Strategic layout of overseas branches and offices in 16 countries and regions. Owns local logistic center in Japan, Turkey and Australia; Set up overseas technical and sales teams to provide all-round localization service.



HISTORICAL EVOLUTION

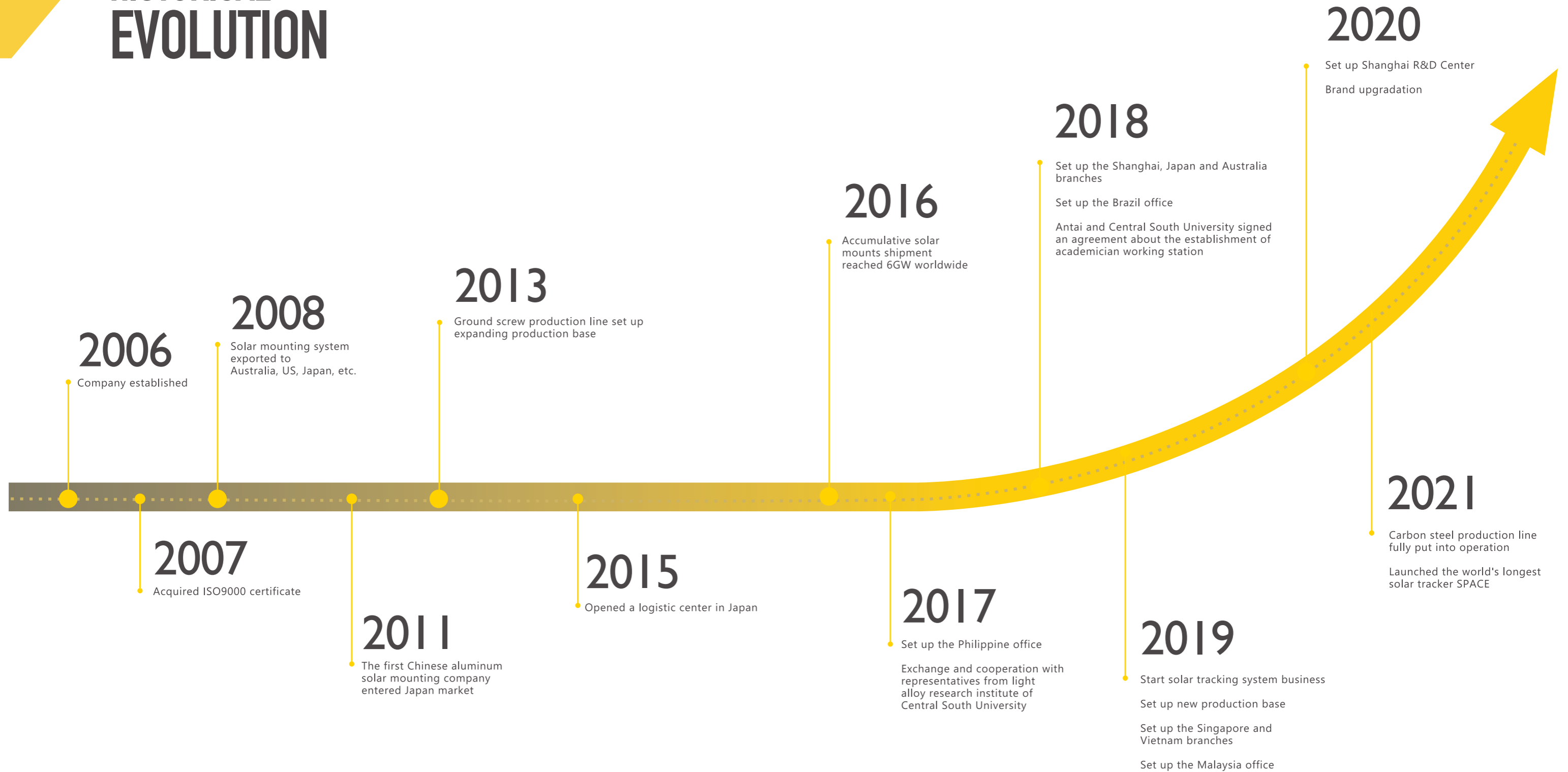

GLOBAL DEPLOYMENT

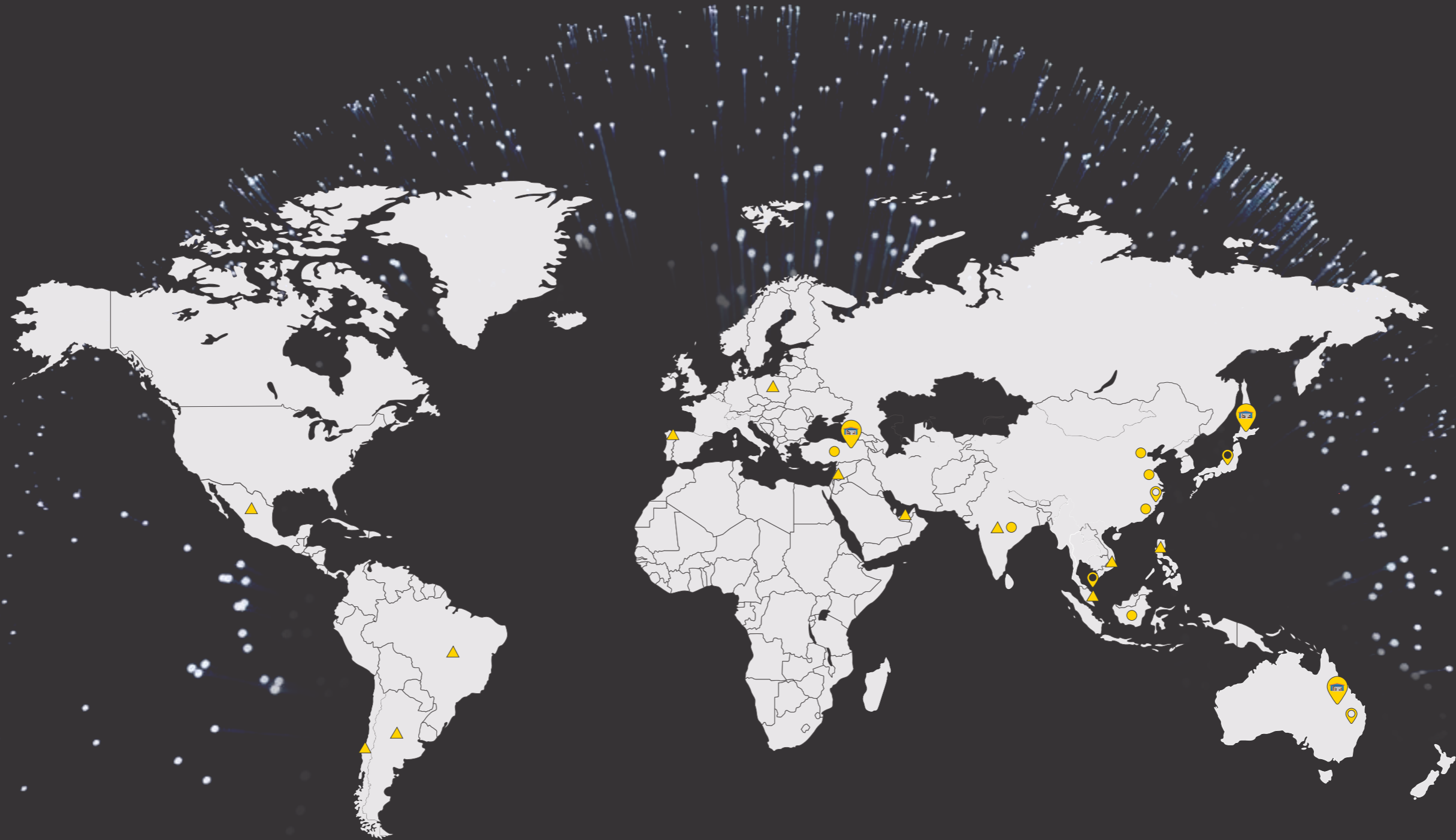

Offices

- | | | | |
|-----------|--------|-------------|---------|
| Argentina | Dubai | Malaysia | Poland |
| Brazil | India | Mexico | Spain |
| Chile | Jordan | Philippines | Vietnam |



Branches

- | | |
|-----------|-----------|
| Australia | Shanghai |
| Japan | Singapore |



Production Bases

- | | |
|-----------|---------|
| Fujian | Tianjin |
| Indonesia | Turkey |
| Jiangsu | India |



Warehouse

- | | | |
|-----------|-------|--------|
| Australia | Japan | Turkey |
|-----------|-------|--------|

VERTICAL INTEGRATED PRODUCTION

Aluminum Mounting System

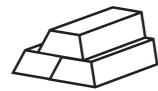

Ingots

01



Casting

02

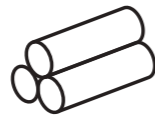

Billets

03

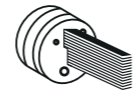

Extrusion

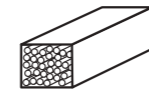

Aging

04

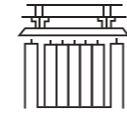

Anodizing

05



Fine finishing

06



Quality inspection

07



Shipment

09

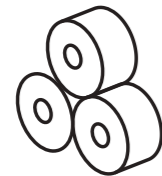

Steel material

01

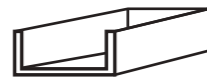

Forming

02

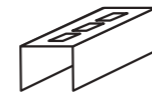

Punching

03

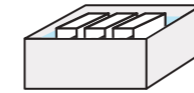

Surface treatment

04



Packing

08

Steel Mounting System



QUALITY CONTROL

In-House Lab Testing

Spectrum Analyzer

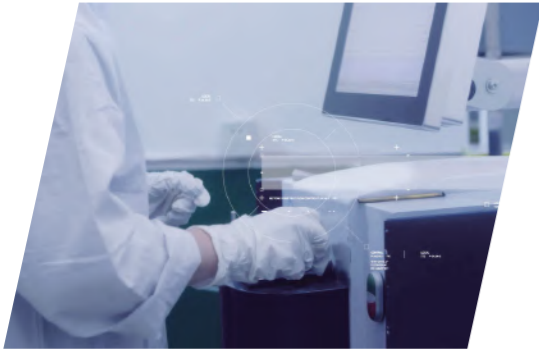

Anti-pull force testing



Chemical Element Testing



Film Thickness Testing



Salt Spray Testing

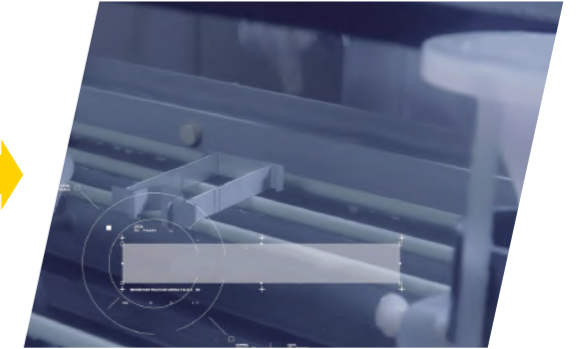

Sample Inspection

Own factory with complete aluminum and steel production chain. A quality-guarantee system for our aluminum products consists of our advanced testing equipment, excellent inspectors and thorough QC management. Whole process inspection from raw material to finished product including section size, thickness, torsion, bending, angle, surface quality, etc.

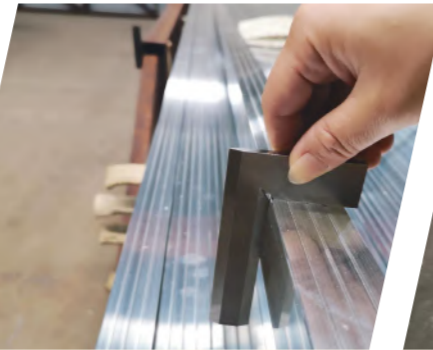

Preliminary Angle



Precise Angle Deviation



Cross Section Width



Thickness Measurement



Hardness Measurement

Third party certification

Products are certified by third-party testing agencies in different worldwide regions to ensure that product performance meets architectural and design standards for global regions.

Certified by third-party testing agencies regularly



Material R&D

Establish an academician and expert workstation with Central South University to carry out research and development of high-performance materials; Deepen school-enterprise cooperation with Shanghai Jiaotong University and other domestic institutions of higher learning to promote all-round integration of industrial technologies.

Unique High performance Aluminum alloy

Items (Mechanical properties)	AL6063-T5	AT6005-T5	Antai AL6005-T6
Tensile strength(MPa)	175	250	290
Proof strength(MPa)	130	200	265
Elongation after fracture(%)	7	7	10

GLOBAL SERVICE



Global network & localization service

- Strategic layout of overseas branches and offices
- Local sales and technical team service



Experienced engineer & site support

- On-site technical support in early stage of project
- On-site technical installation guidance if necessary



Professional logistics

- Customized logistics services provided for fast access to site
- Globally warehouse layout



Reliable after-sales service

- 10 years warranty
- 7*24 on call, designing proposal offered within 24 hours
- Multilingual, 1 to 1 exclusive customer service

CONTENTS



PITCHED ROOF

- 13 L foot mount
- 15 Tile roof mount
- 17 Standing seam mount
- 19 Railless metal roof mount

FLAT ROOF

- 21 Adjustable tilt roof mount
- 23 Triangle roof mount
- 25 Railless ballasted mount

GROUND

- 27 Ground mount
- 29 Pile ground mount
- 31 Steel ground mount

CARPORT

- 33 Aluminum carport mount
- 35 Aluminum carport mount-waterproof
- 37 Steel carport mount

SCREW

- 39 Ground screw

L FOOT SOLAR MOUNTING SYSTEM

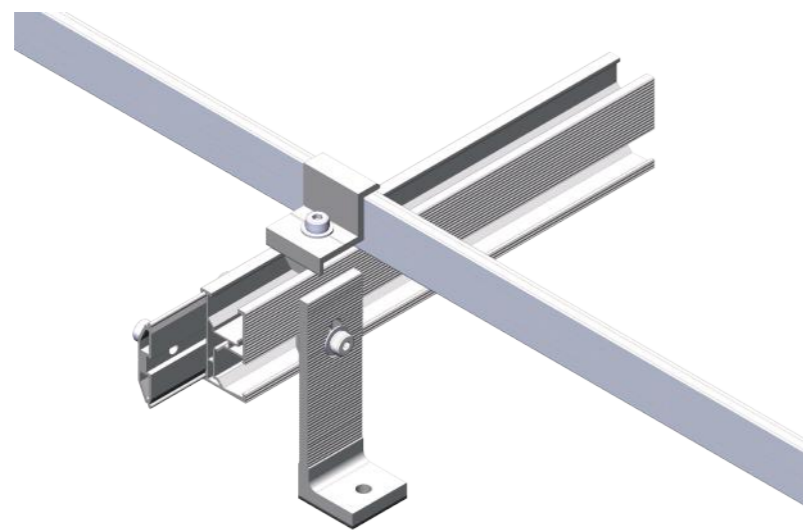

Components



A : L bracket



B : Rail

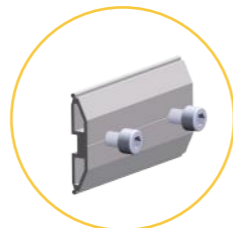

C : Rail splice

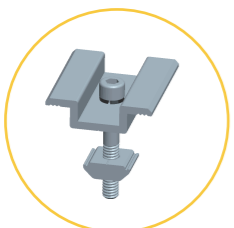

D : Inter clamp



E : End clamp



Features

- 01** Good flexibility to match various types of roof clamps.
- 02** Good stability when attached directly on roof purling.
- 03** Compliant with the Australian and other international standards.

Specification

Application	Pitched roof
Roof Slope	Up to 60°
Building height	Up to 20m
Roof cladding	Suitable for most types of cladding
Recommended wind speed	Up to 60 m/s
PV module	Framed, unframed
Module orientation	Landscape, portrait
Material	Anodized aluminum 6005 T6 stainless steel 304

TILE ROOF SOLAR MOUNTING SYSTEM

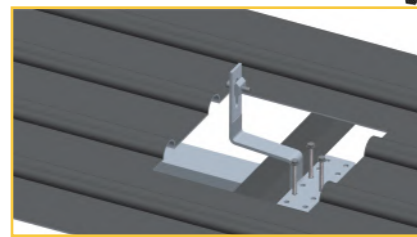
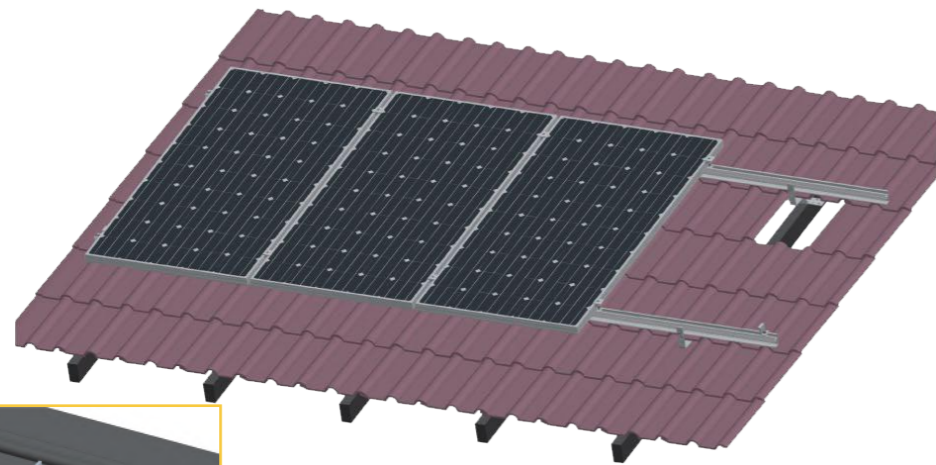

Components



A : Tile roof hook

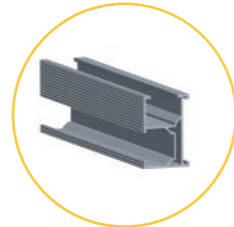

B : Rail



C : Rail splice

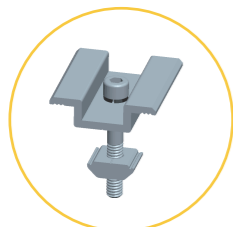

D : Inter clamp



E : End clamp



Side view



Features

- 01 A variety of stainless steel roof hooks suit for pantile, plain tile or slate tiles.
- 02 Comprehensive range of aluminum rails for varying load profiles.
- 03 Compliant with the Australian and other international standards.

Specification

Application	Pitched roof
Roof Slope	Up to 60°
Building height	Up to 20m
Roof cladding	Suitable for most types of cladding
Recommended wind speed	Up to 60m/s
PV module	Framed, unframed
Module orientation	Landscape, portrait
Material	Anodized aluminum 6005 T6 stainless steel 304



STANDING SEAM ROOF MOUNTING SYSTEM

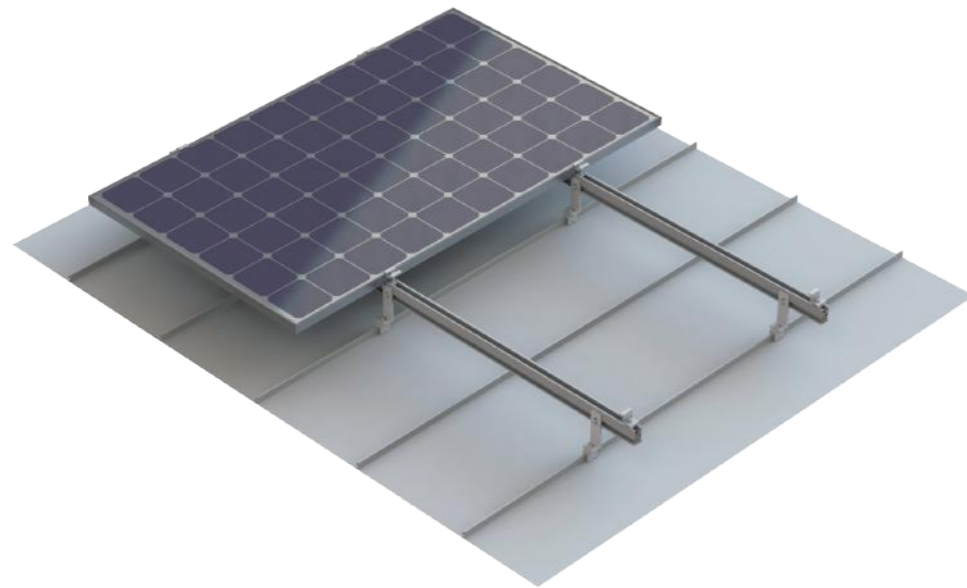

Components



A: Standing seam clamp

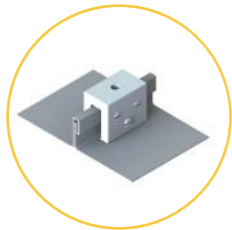

B: Locked seam®

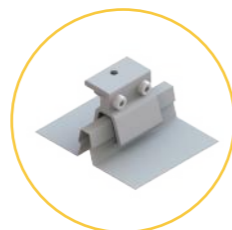

Kliplok® 406

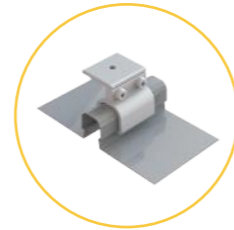

Kliplok® 700

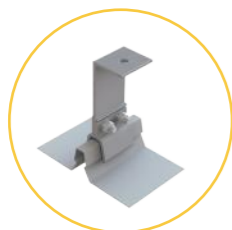

TYN-382 clamp



TYN-385 clamp

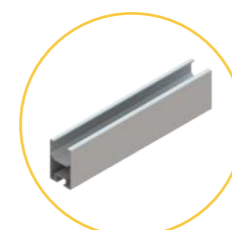

Rail

Features

- 01** Non-penetrating roof clamp mounting ensures watertightness.
- 02** A variety of roof clamps suit for all roofing sheets.
- 03** Simple and quick installation by attaching the clamp to the standing seams.
- 04** Expand installation availability while without suitable fix beam.

Specification

Application	Suitable for Lysaght® Kliplok® 406, 700, Lysaght® Locked seam®, Stramit® Speed Deck, Fielders®
Roof Slope	Up to 60°
Building height	Up to 20m
Recommended wind speed	Up to 60 m/s
PV module	Framed, unframed
Module orientation	Landscape, portrait
Material	Anodized aluminum 6005 T6 stainless steel 304

RAILLESS METAL SHEET MOUNTING SYSTEM



10 years warranty



Components

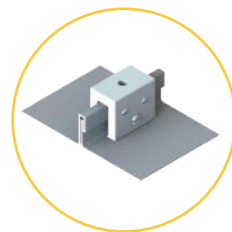

A : Locked seam®

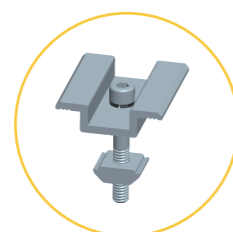

B : Inter clamp



C : End clamp

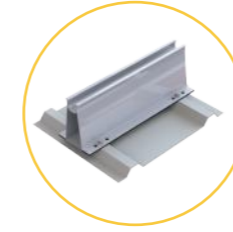

Railless roof clamp

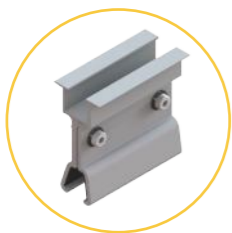

Kliplok® 406

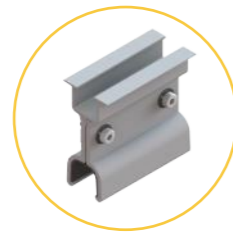

Kliplok® 700



Kliplok® 406



Kliplok® 700

Features

- 01 Fast installation without rail and saving cost.
- 02 EPDM gaskets under attachments to protection from water leakage.
- 03 Railless mounting system allows for easy logistics, cost-effective warehousing.
- 04 Length of roof attachment can be customized.

Specification

Application	Trapezoidal sheet, sandwich roofing, standing seam
Roof Slope	Up to 60°
Building height	Up to 20m
Min. sheet thickness	0.8mm minimum
Recommended wind speed	Up to 60 m/s
PV module	Framed, unframed
Module orientation	Landscape, portrait
Material	Anodized aluminum 6005 T6 stainless steel 304, 410

ADJUSTABLE TILT FLAT ROOF MOUNTING SYSTEM



10 years warranty

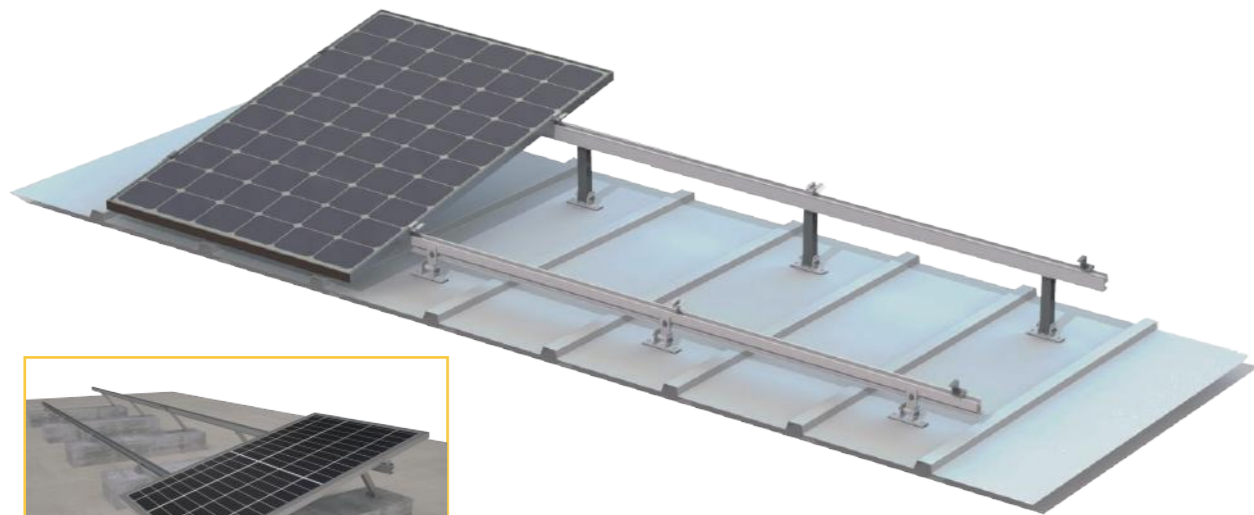

Concrete Foundation

Components

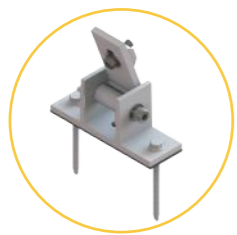

A : Front leg



B : Back leg



C : Rail

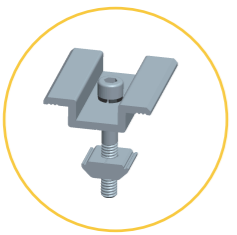

D : Inter clamp



E : End clamp

Features

- 01** Allow for project-specific adjustments and optimize solar power output.
- 02** Compact package before shipment for easy transportation and retail.
- 03** Fit for different metal roof or open concrete terrain applications.
- 04** Highly pre-assembly to save on site installation time.

Specification

Application	Pitched roof, flat roof
Roof Slope	Up to 60°
Building height	Up to 20m
Tilt angle	Fixed, 10-15°, 15-30°, 30-60°
Recommended wind speed	Up to 60 m/s
PV module	Framed, unframed
Module orientation	Landscape, portrait
Material	Anodized aluminum 6005 T6, stainless steel 304, 410

TRIANGLE FLAT ROOF MOUNTING SYSTEM

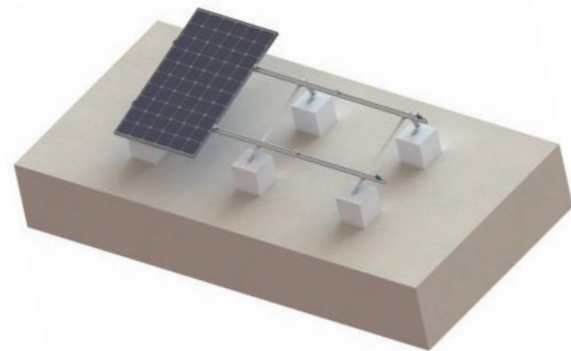

Concrete Foundation



Metal Roof

Components



A1 : Bottomless triangle bracket



A2 : Triangle bracket



C : Rail splice



D : Rail

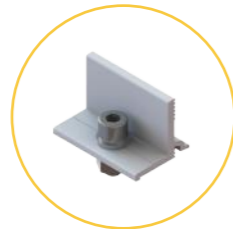

E : Rail clamp



D: Inter/ End clamp

Features

- 01 Universal design for flat roof or open terrain applications.
- 02 Various combinations such as ballasted block or roof penetration.
- 03 Pre-assembly triangle support and fold design save on site installation time.

Specification

Application	Pitched roof, flat roof
Tilt angle	10°, 15°, 20°, 30°
Building height	Up to 20m
Snow load	Up to 99cm
Recommended wind speed	Up to 60m/s
PV module	Framed, unframed
Module orientation	Landscape, portrait
Material	Anodized aluminum 6005 T6 stainless steel 304, 410

RAIL-FREE BALLASTED FLAT MOUNTING SYSTEM

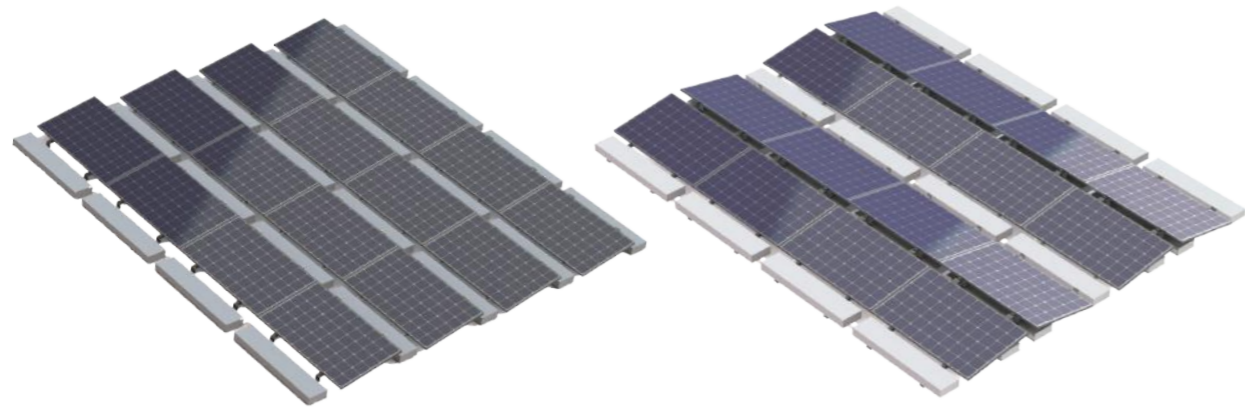

Components

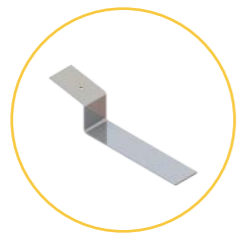

A1 : Front support A

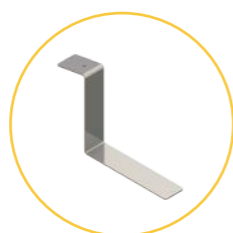

B1 : Rear support A



C1 : Inter support A

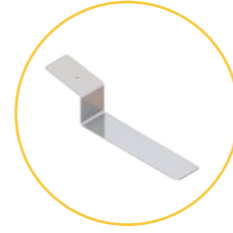

A2 : Front support B



B2 : Inter support B



C2 : Inter support C

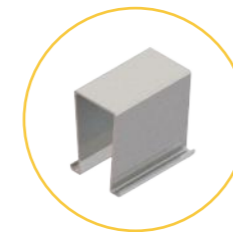

D : Buckle

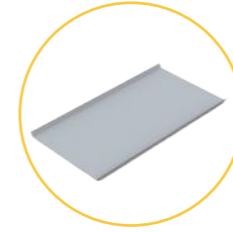

E : Ballast tray

Features

- 01** Non-penetrating roof clamp mounting ensures watertightness.
- 02** No drilling or digging, without roof penetration.
- 03** Ballast weight is customizable to different wind zone.

Specification

Application	Flat roof, open terrain
Tilt angle	5°, 10°
Building height	Up to 24m
Recommended wind speed	Up to 60m/s
PV module	Framed, unframed
Module orientation	Landscape recommended
Material	Anodized aluminum 6005 T6 stainless steel 304, 410



GROUND MOUNTING SYSTEM

Concrete foundation

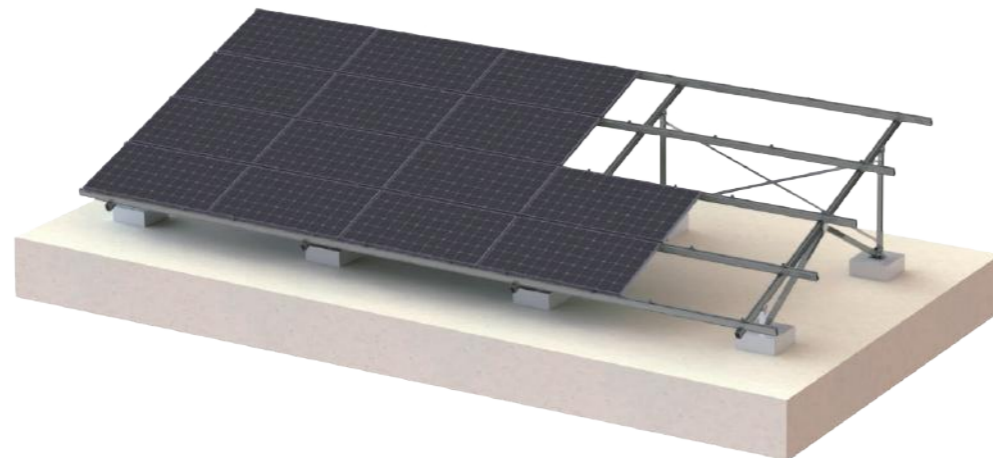

Ground screw foundation

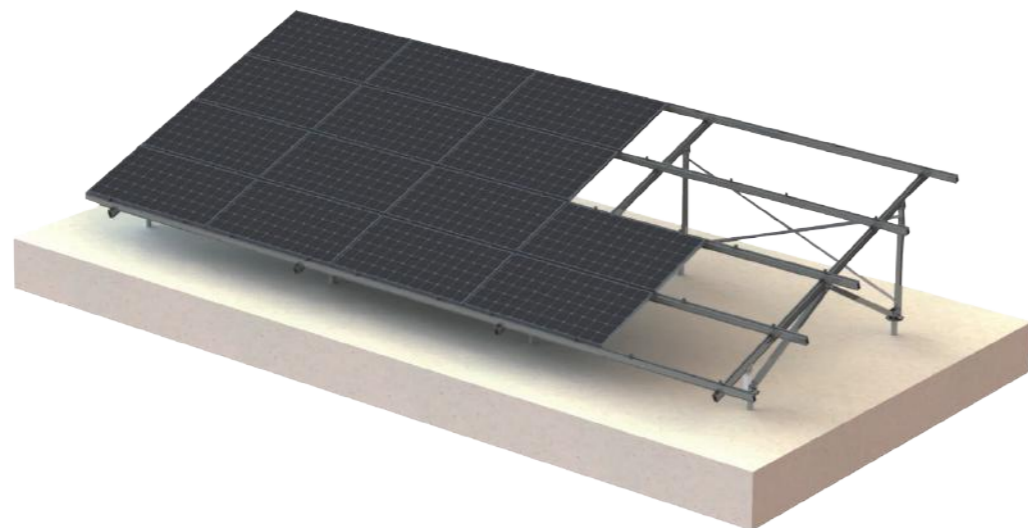

Features

- 01** Aluminum structure to offer high corrosion resistant and lightweight.
- 02** Different designs to meet high loads caused by local wind and snow condition.
- 03** Pre-assembly supporting beam to save on site installation time.
- 04** Ground screw or concrete block foundation are optional.

Specification

Application	Open terrain, landfill, and disposal
Elevation angle	Up to 60°
Distance between footings	Depending on load condition, refer to manual
Snow load	Up to 50cm
Recommended wind speed	Up to 60 m/s
PV module	Framed, unframed
Module orientation	Landscape, portrait
Material	Anodized aluminum 6005 T6 stainless steel 304 Hot-dipped galvanized steel Q235B, Q355B

10 years warranty

PILE GROUND MOUNTING SYSTEM

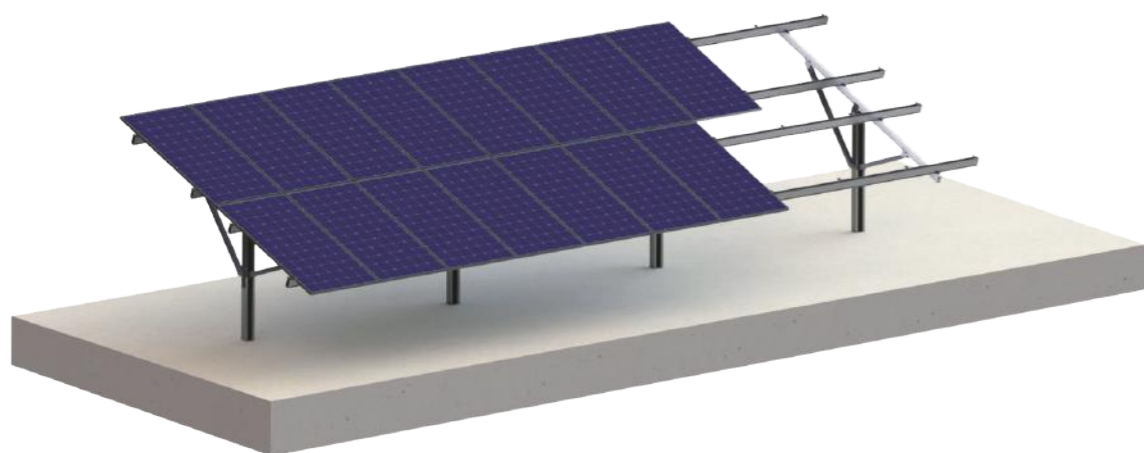

Components



A : Pre-assembled beam

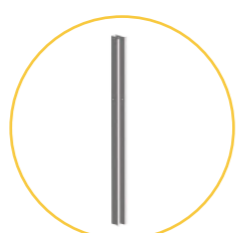

B : Pillar



C : Rail



D : Rail splice



E : Pillar cap



F : Rail clamp

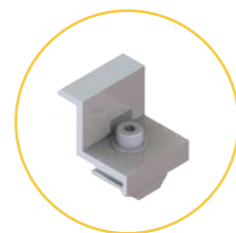

G : End clamp

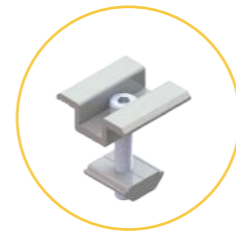

H : Inter clamp

Features

- 01** Fit for flat ground, uneven complex terrain and slope conditions.
- 02** Flexible adjustment for angles or height while installation.
- 03** Pre-assembly supporting beam to save on site installation time.
- 04** Ramming posts eliminates the need for additional excavation works.

Specification

Application	Open terrain
Elevation angle	Up to 60°
Foundation	Pile in or pre-cast, bored pier
Snow load	Up to 150cm
Recommended wind speed	Up to 60 m/s
PV module	Framed, unframed
Module orientation	Landscape, portrait
Material	Anodized aluminum 6005 T6, stainless steel 304, 410 Hot-dipped galvanized steel Q235B, Q235B

10 years warranty

STEEL GROUND MOUNTING SYSTEM

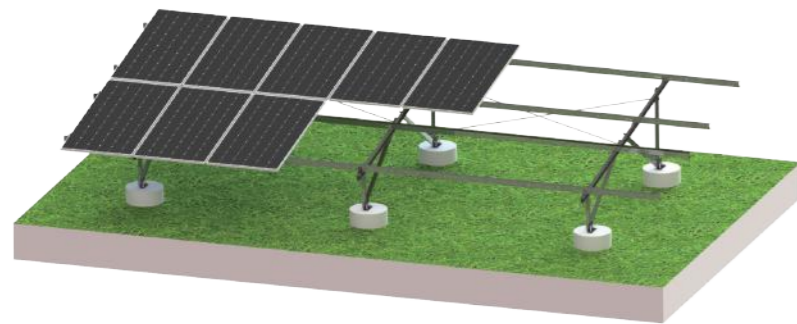

Concrete Foundation

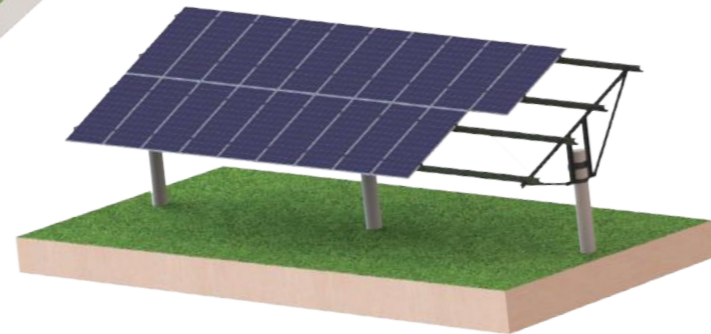

PHC

Components



A : C steel rail



B : Pillar



C : Rail splice



D : L Connector



E : Rail clamp



D: Inter/ End clamp



Features

- 01** Economical and reliable solutions for solar projects on a free surface.
- 02** MAC steel or carbon steel is adopted as the main material to form a stable and cost-effective design.
- 03** Pre-assembly supporting beam to save on site installation time.
- 04** Ground screw or concrete block foundation are optional.

Specification

Application	Open terrain
Adjustable angle	Up to 20°
Foundation	7500mm above
Snow load	Up to 150cm
Recommended wind speed	Up to 60m/s
PV module	Framed, unframed
Module orientation	Landscape, portrait
Material	MAC steel; Hot-dipped galvanized steel Q235B, Q355B; stainless steel 304, 410

ALUMINUM CARPORT SOLAR MOUNTING SYSTEM

10 years warranty

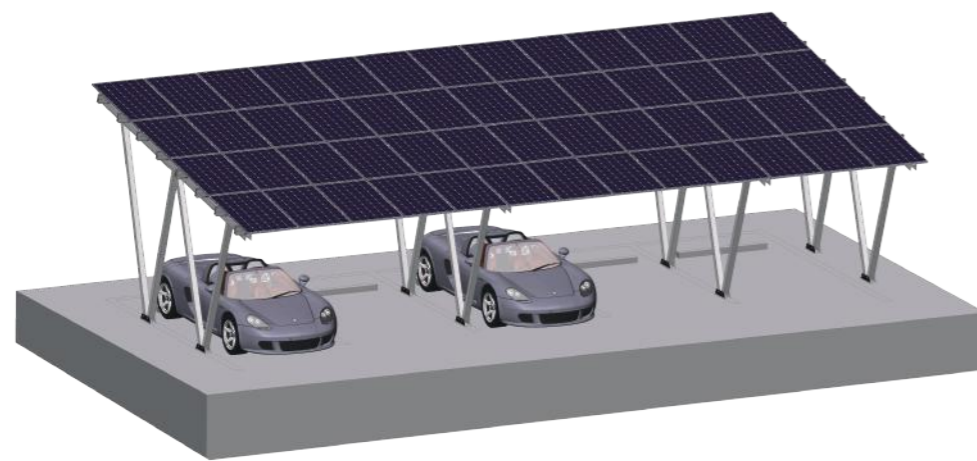

Components



A : Beam connector

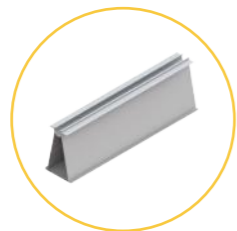

B : Rail



C : Rail splice

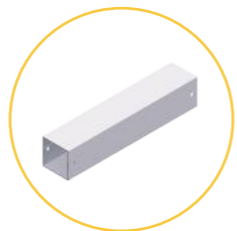

D : Pole



E : Foot seat

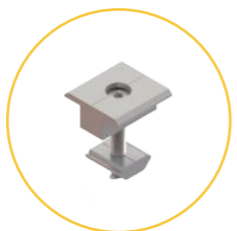

G : Inter clamp

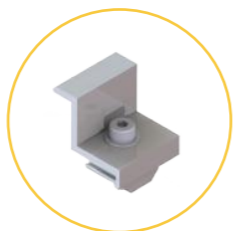

H : End clamp



I : Rail clamp

Features

- 01** Effectively use of the space while generating electricity.
- 02** Different options for both single and double rows of parking.
- 03** Pre-assembly supporting beam to save on site installation time.
- 04** Various foundation options include precast concrete, bored pier and ground screw.

Specification

Application	Open terrain
Elevation angle	Recommend below 30°
Distance between footings	5000mm above
Snow load	Up to 150cm
Recommended wind speed	Up to 60m/s
PV module	Framed, unframed
Module orientation	Landscape, portrait
Material	Anodized aluminum 6005 T6 stainless steel 304, 410 Hot-dipped galvanized steel Q235B, Q355B

ALUMINUM CARPORT MOUNTING SYSTEM-WATERPROOF



Components

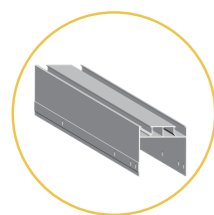

A : Supporting Beam

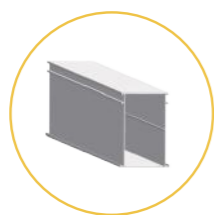

B : Rail

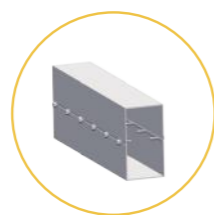

C : Rail splice

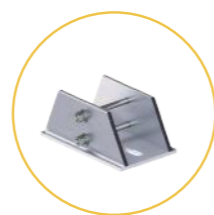

D : Big foot seat



E : Small foot seat

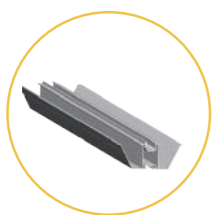

F : Water guide rail



G : Water guide rail splice



H : Cover plate



I : Water guide gutter



J : Inter/ End clamp



Features

- 01** Effectively use of the space while generating electricity.
- 02** Fully waterproof design for framed module installation.
- 03** Pre-assembly supporting beam to save on site installation time.
- 04** Various foundation options include precast concrete, bored pier and ground screw.

Specification

Application	Open terrain
Elevation angle	Recommend below 30°
Distance between footings	5000mm above
Snow load	Up to 150cm
Recommended wind speed	Up to 60 m/s
PV module	Framed, unframed
Module orientation	Landscape, portrait
Material	Anodized aluminum 6005 T6 stainless steel 304 Hot-dipped galvanized steel Q235B, Q355B

10 years warranty

STEEL CARPORT MOUNTING SYSTEM

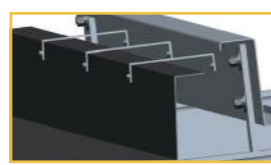

Components

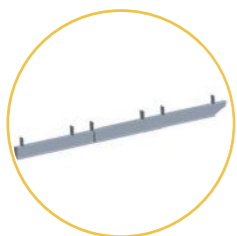

A : Supporting beam

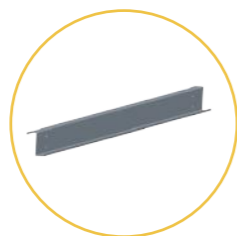

B : Horizontal beam

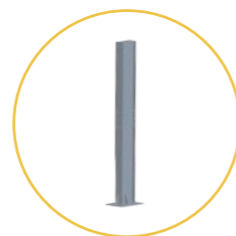

C : Pole

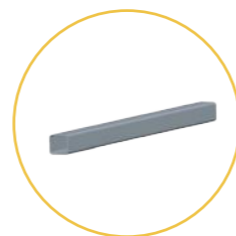

D : Bracing



E : Hook

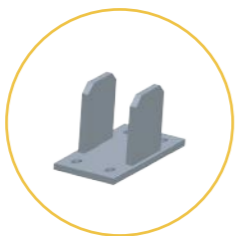

F : Connector

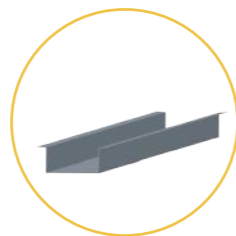

G : Water guide gutter



H : Inter/ End clamp

Features

- 01** Effectively use of the space while generating electricity.
- 02** Strong stability steel structure with larger span to reduce cost.
- 03** Pre-assembly supporting beam to save on site installation time.
- 04** Various foundation options include precast concrete, bored pier and ground screw.

Specification

Application	Open terrain
Elevation angle	Up to 20°
Distance between footings	7500mm above
Snow load	Up to 150cm
Recommended wind speed	Up to 60m/s
PV module	Framed, unframed
Module orientation	Landscape, portrait
Material	Anodized aluminum 6005 T6 stainless steel 304 Hot-dipped galvanized steel Q235B, Q355B



HOT-DIP GALVANIZED STEEL GROUND SCREW

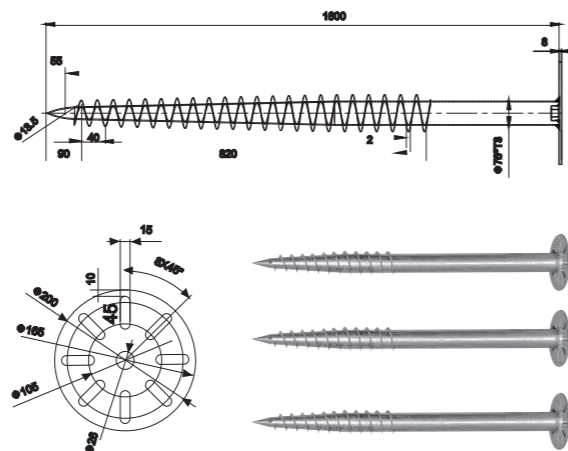
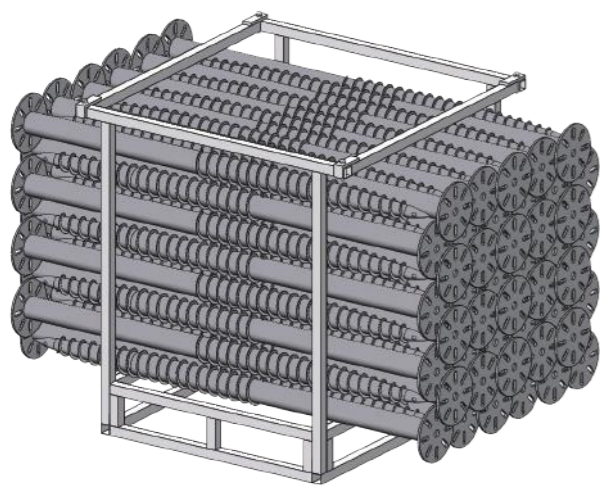

Manual piling diver

Easy operation, cost effecton for small size ground project.

Pile diver

High installation effeciency, 30-75s for one screw in, ideal for large scale project.



Features

- 01** Ground screw foundation allows for a screamlined design and a very cost-effect ground mount system. Using less concrete, no excavation, especially useful for sites with restricted access or environmental sensitivity.
- 02** High adaptability can be widely used in all kinds of geological conditions, such as foreshore, desert, grassland, etc.
- 03** Average 80um galvanization ensure high corrosion resistance without additional treatmentl.

Length can be customized

Item No.	Length	Out Dia.	Thickness	Flange Out Dia.	Material
AT76xT3.5x1200 AT76xT3.5x1400 AT76xT3.5x1600 AT76xT3.5x1800 AT76xT3.5x2000	1200mm 1400mm 1600mm 1800mm 2000mm	76mm	3.5mm	220mm	Hot dipped galvanized steel, Q235B
AT76xT3x1200 AT76xT3x1400 AT76xT3x1600 AT76xT3x1800 AT76xT3x2000	1200mm 1400mm 1600mm 1800mm 2000mm	76mm	3mm	200mm	Hot dipped galvanized steel, Q235B

Our accessories

Key elements to a successful PV installation

Our full range of useful accessories diversify the portfolio of Antaisolar PV mounting systems, and constantly being complemented in line with the market needs. Highly customization, flexibility, convenience to install, quality is the primary concern.

Accessories for example

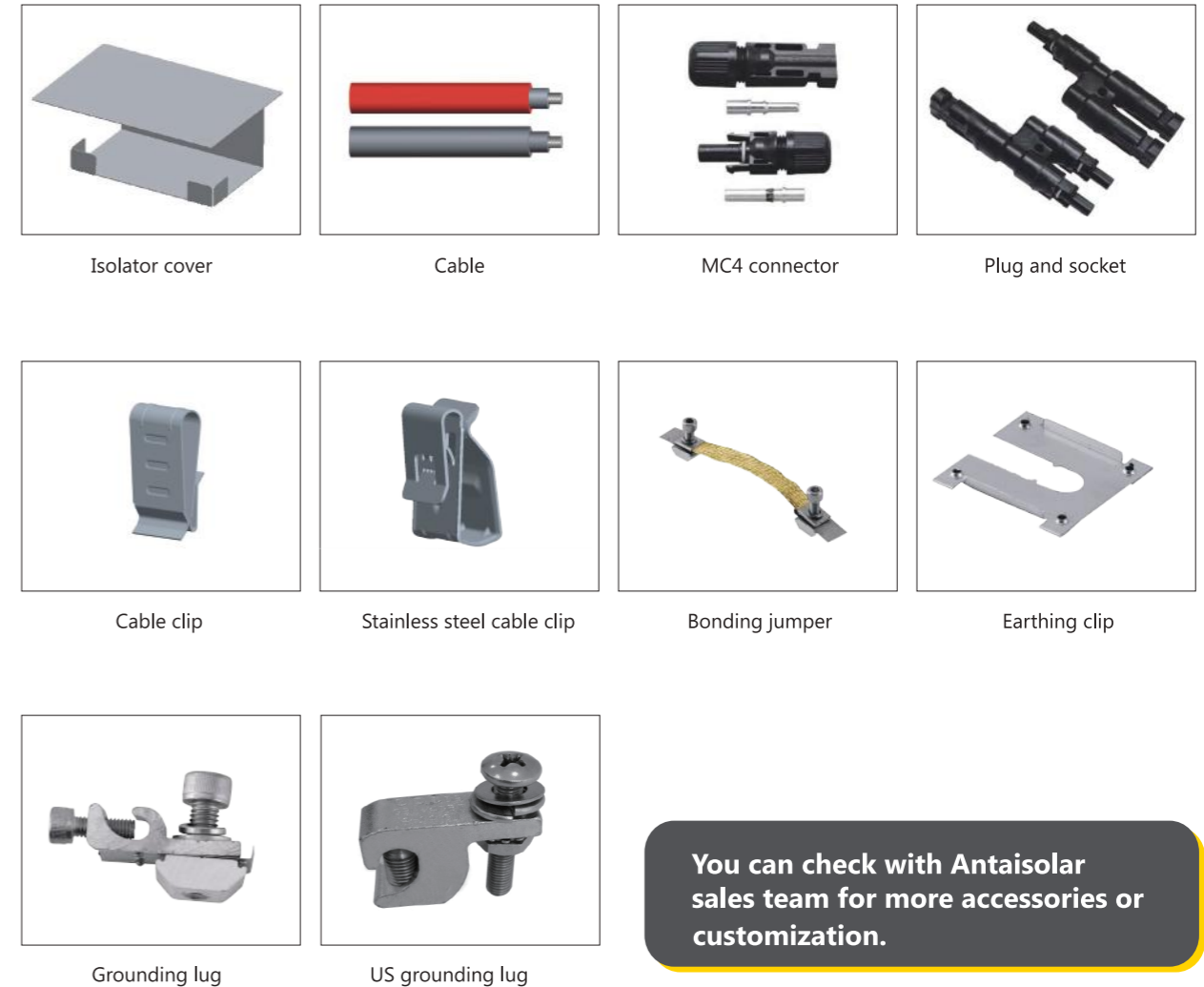

Modern installation solution for earthing, electrical bonding and lightning protection

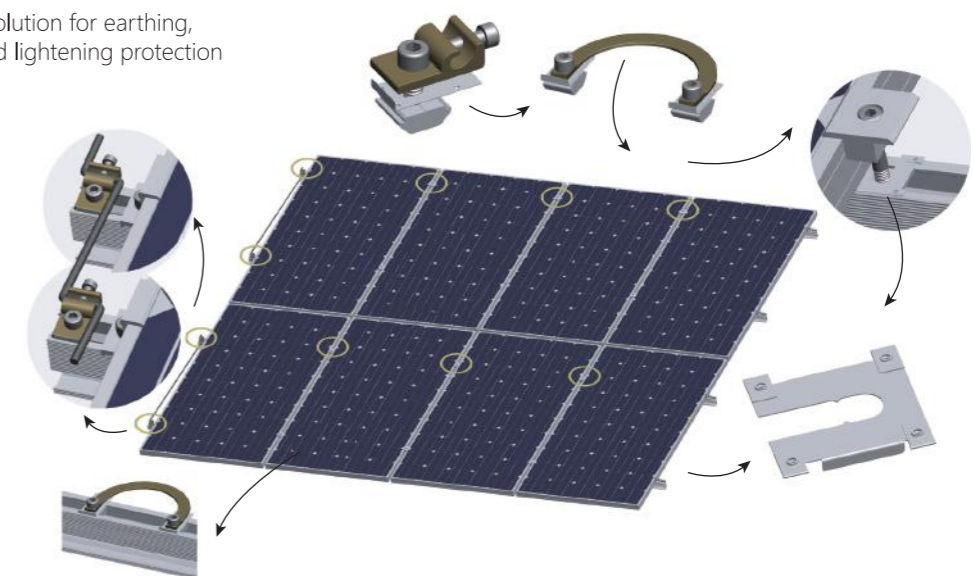

Subject to errors and technical modifications. 2020©Fujian Antai New Energy Tech. Co.,Ltd

